

Part No. AS2812-U-0100-075-D



Type EI28/12

Power 1.0 VA

Weight 70 g

shipping unit per box: 40 PCS

temperature class: ta 70°C/B

Safety transformer/Short circuit proof

Vacuum filled casting

Split bobbin design winding

Dielectric strength 4500Vrms

PART NO	Output ta 70°C/B	Prim.V	Connecting pins	Operating point sec. ± 10%	Connecting pins	No-load voltage V ± 10%
AS2812-U-0100-075-D	1.0W	115	1--5	7.5V 66.6mA	6--7	10.0V
				7.5V 66.6mA	9--10	10.0V

According to

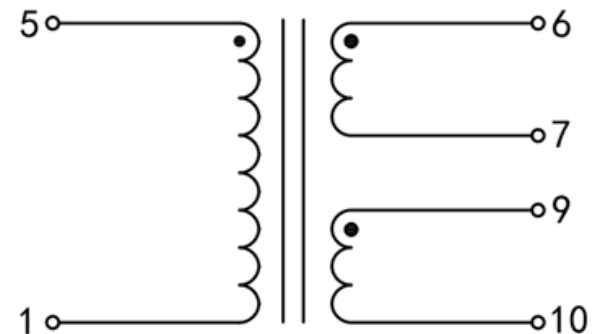
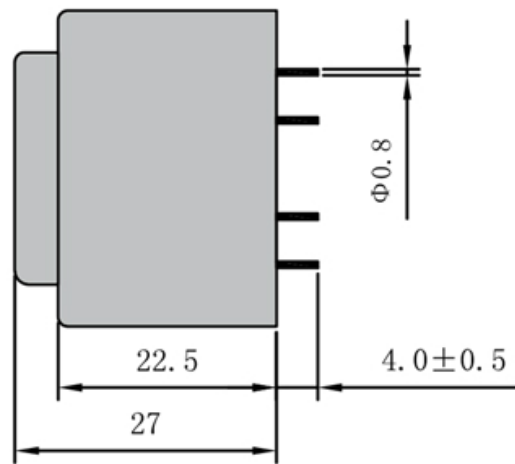
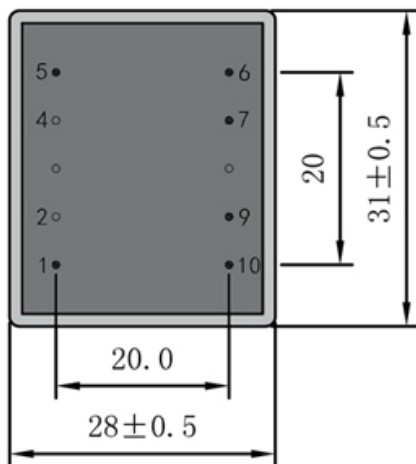

Dimensions with no indication of tolerances: ± 0.3mm
Custom-made transformer also will be welcome.

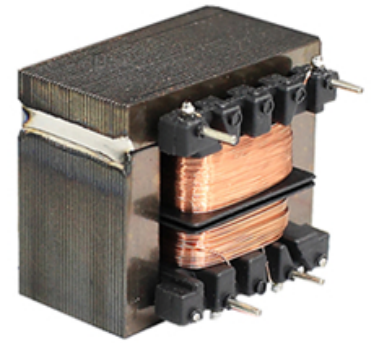

ADD: 699 Fangzhou Road Xiongzhou Town Luhe District 211500 Nanjing City Jiangsu China
TEL: +86 25 57120866 / 57120966 - 8001 FAX: +86 25 57118989
E-mail: asn@asn.cn / asn@asntransformer.com
http://www.asntransformer.com