

Part No. ASE3012-E-0120-240-D



Type EI30/12.5

Power 1.2VA

Weight 85g

shipping unit per box: 40 PCS

temperature class: ta 70°C/B

Max.standby power consumption ≤0.5W

Safety transformer/Short circuit proof

Vacuum filled casting

Split bobbin design winding

with VDE, ENEC 10, UL ,CE,CB certificates

Dielectric strength 4500Vrms

PART NO	Output ta 70°C/B	Prim.V	Connecting pins	Operating point sec. ± 10%	Connecting pins	No-load voltage V ± 10%
ASE3012-E-0120-240-D	1.2W	230	1--5	24V 25.0mA	6--7	32.8V
				24V 25.0mA	9--10	32.8V

Approved by

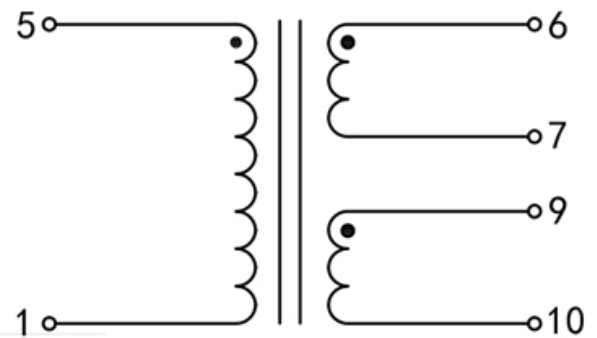
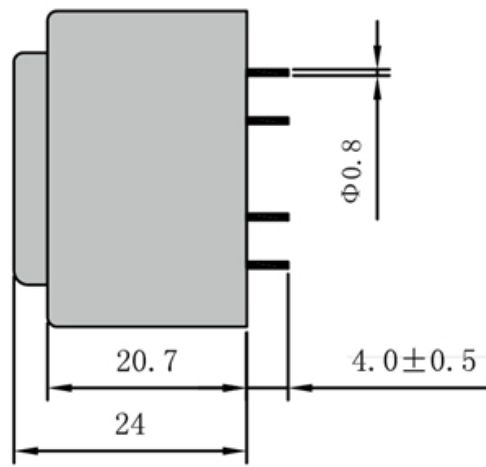
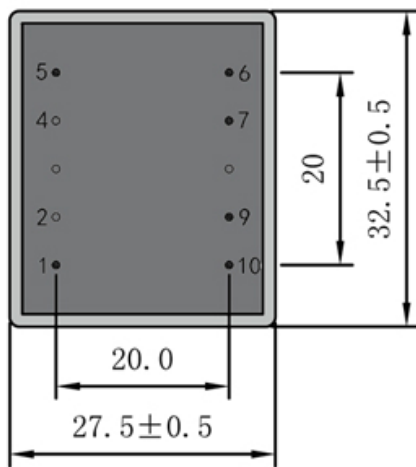

Dimensions with no indication of tolerances: ± 0.3mm
Custom-made transformer also will be welcome.



ADD: 699 Fangzhou Road Xiongzhou Town Luhe District 211500 Nanjing City Jiangsu China

TEL: +86 25 57120866 / 57120966 - 8001 FAX:+86 25 57118989

E-mail: asn@asn.cn / asn@asntransformer.com

http://www.asntransformer.com