

Part No. ASU3016-U2-1000-240-D



Type UI30/16.5

Power 10.0 VA

Weight 260g

shipping unit per box: 18 pcs temperature class: ta 50°C/B

Vacuum filled casting

Split bobbin design winding

Dielectric strength 3750Vrms

PART NO	Output ta 50°C/B	Prim.V	Connecting pins	Operating point sec. ± 10%	Connecting pins	No-load voltage V ± 10%
ASU3016-U2-1000-240-D	10.0 W	115	1---3	24V 208.3mA	10---12	31.7V
		115	5---7	24V 208.3mA	14---16	31.7V

According to

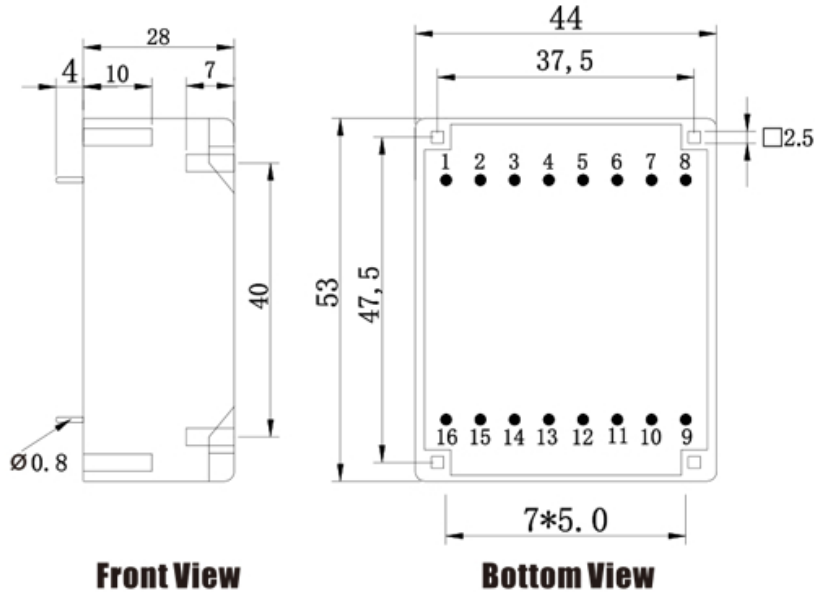

Front View

Bottom View

Tolerances : <10mm ±0.3mm
 10--50mm ±0.5mm
 Custom-made transformer also will be welcome.

Schematics

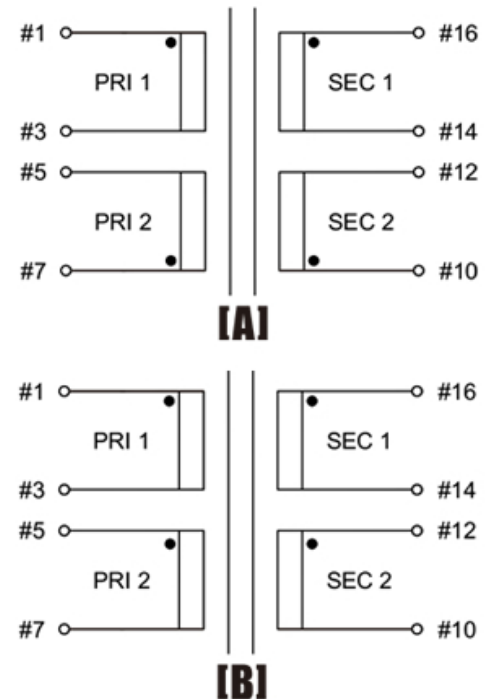

ADD: 699 Fangzhou Road Xiongzhou Town Luhe District 211500 Nanjing City Jiangsu China
 TEL: +86 25 57120866 / 57120966 - 8001 FAX:+86 25 57118989
 E-mail: asn@asn.cn / asn@asntransformer.com
 http://www.asntransformer.com