

Part No. AS3012-U-0150-180-D



Type EI30/12.5

Power 1.5VA

Weight 85g

shipping unit per box: 40 PCS

temperature class: ta 70°C/B

Safety transformer/Short circuit proof

Vacuum filled casting

Split bobbin design winding

with VDE, ENEC 10, UL, CE, CB certificates

Dielectric strength 4500Vrms

PART NO	Output ta 70°C/B	Prim.V	Connecting pins	Operating point sec. ± 10%	Connecting pins	No-load voltage V ± 10%
AS3012-U-0150-180-D	1.5W	115	1--5	18V 41.6mA	6--7	25.5V
				18V 41.6mA	9--10	25.5V

Approved by

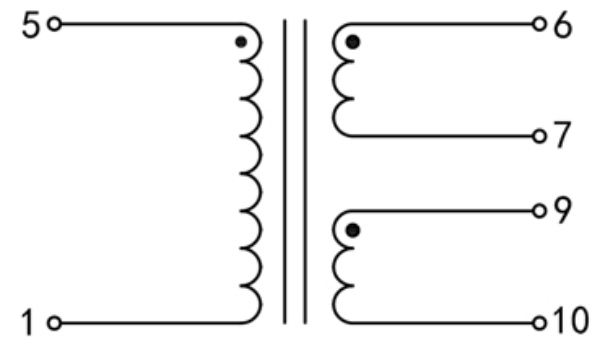
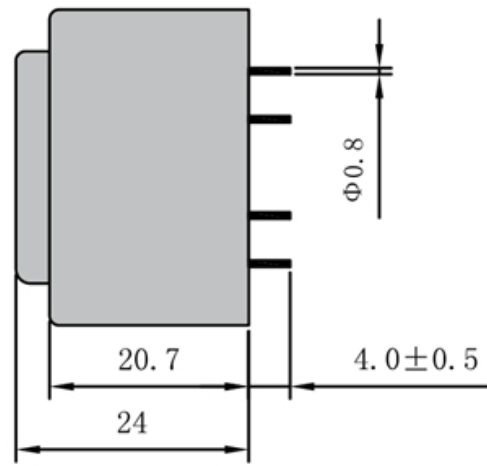
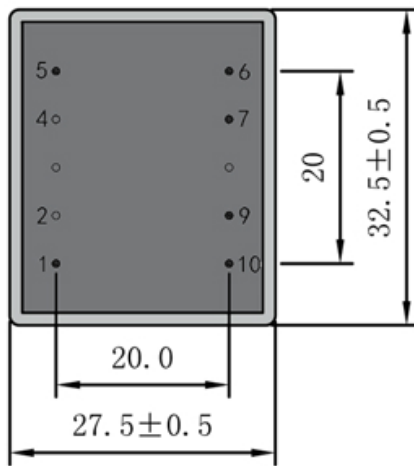

Dimensions with no indication of tolerances: ± 0.3mm

Custom-made transformer also will be welcome.



ADD: 699 Fangzhou Road Xiongzhou Town Luhe District 211500 Nanjing City Jiangsu China

TEL: +86 25 57120866 / 57120966 - 8001

FAX: +86 25 57118989

E-mail: asn@asn.cn / asn@asntransformer.com

http://www.asntransformer.com