

Part No. AS3012-E-0150-060-S



Type EI30/12.5

Power 1.5 VA

Weight 85 g

shipping unit per box: 40 PCS. temperature class: ta 70°C/B

Safety transformer/Short circuit proof

Vacuum filled casting

Split bobbin design winding

with VDE, ENEC 10, UL ,CE,CB certificates

Dielectric strength 4500Vrms

PART NO	Output ta 70°C/B	Prim.V	Connecting pins	Operating point sec. ± 10%	Connecting pins	No-load voltage ± 10%
AS3012-E-0150-060-S	1.5W	230	1--5	6V 250.0mA	7--9	8.8V

Approved by

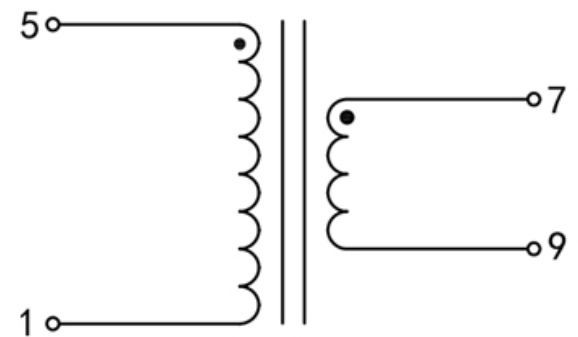
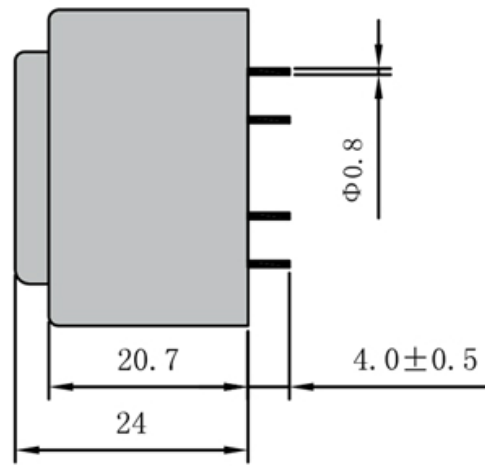
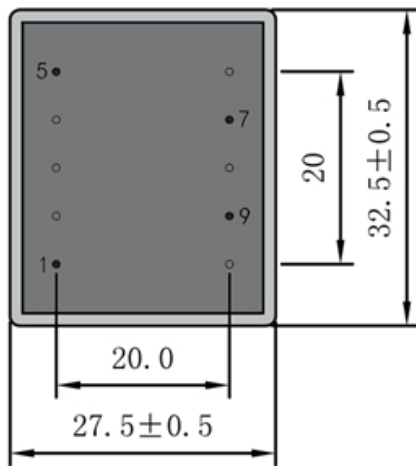

Dimensions with no indication of tolerances: ± 0.3mm  
Custom-made transformer also will be welcome.



ADD: 699 Fangzhou Road Xiongzhou Town Luhe District 211500 Nanjing City Jiangsu China  
TEL: +86 25 57120866 / 57120966 - 8001 FAX: +86 25 57118989  
E-mail: asn@asn.cn / asn@asntransformer.com  
http://www.asntransformer.com