

Part No. AS3010-U2-0150-180-S



Type EI30/10.5

Power 1.5VA

Weight 70g

shipping unit per box: 40 PCS

temperature class: ta 50°C/B

Safety transformer/Short circuit proof

Vacuum filled casting

Split bobbin design winding

with VDE, ENEC 10, UL, CE, CB certificates

Dielectric strength 4500Vrms

PART NO	Output ta 50°C/B	Prim.V	Connecting pins	Operating point sec. ± 10%	Connecting pins	No-load voltage V ± 10%
AS3010-U2-0150-180-S	1.5W	115	1--2	18V 83.3mA	7--9	26.5V
		115	4--5			

Approved by

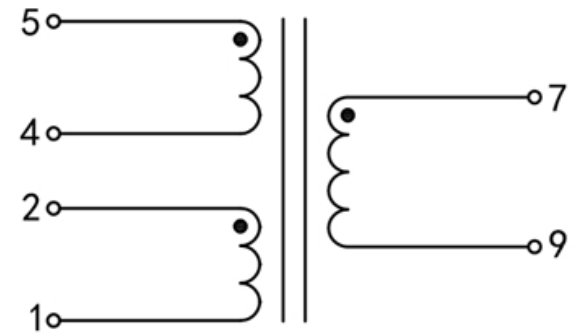
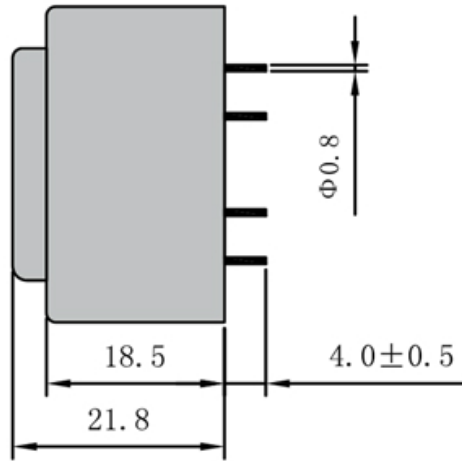
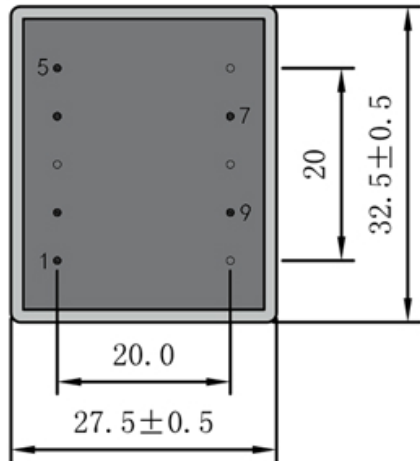

Dimensions with no indication of tolerances: ± 0.3mm  
Custom-made transformer also will be welcome.

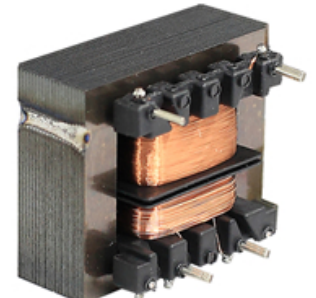

ADD: 699 Fangzhou Road Xiongzhou Town Luhe District 211500 Nanjing City Jiangsu China

TEL: +86 25 57120866 / 57120966 - 8001

FAX: +86 25 57118989

E-mail: asn@asn.cn / asn@asntransformer.com

http://www.asntransformer.com