

Part No. AS4820-E-1200-060-D



Type EI48/20

Power 12.0VA

Weight 350g

shipping unit per box: 20 PCS

temperature class: ta 70°C/B

**Vacuum filled casting**

Split bobbin design winding

**Dielectric strength 4500Vrms**

PART NO	Output ta 70°C/B	Prim.V	Connecting pins	Operating point sec. ± 10%	Connecting pins	No-load voltage V ± 10%
AS4820-E-1200-060-D	12.0W	230	1--6	6V 1000.0mA	7--8	7.5V
				6V 1000.0mA	11--12	7.5V

According to

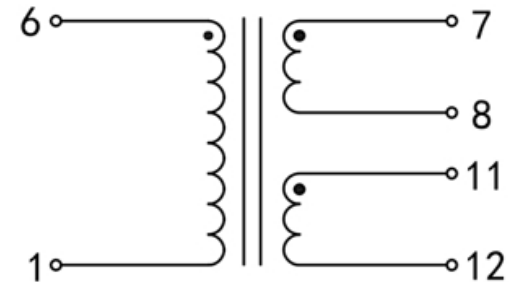
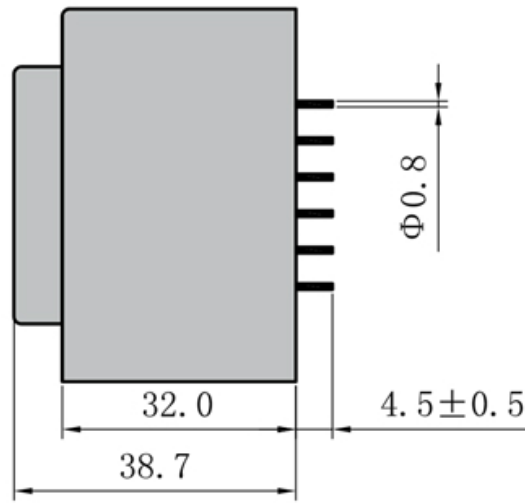
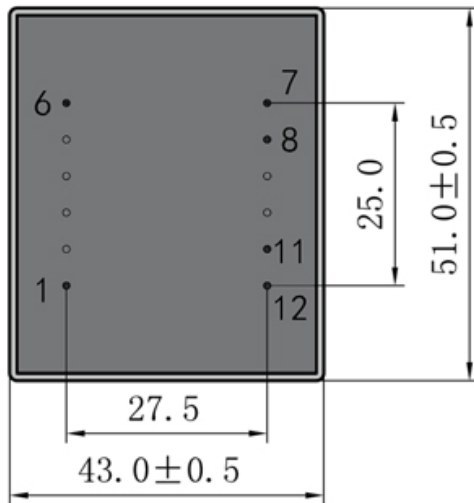

Dimensions with no indication of tolerances: ± 0.3mm  
Custom-made transformer also will be welcome.



ADD: 699 Fangzhou Road Xiongzhou Town Luhe District 211500 Nanjing City Jiangsu China  
 TEL: +86 25 57120866 / 57120966 - 8001 FAX: +86 25 57118989  
 E-mail: asn@asn.cn / asn@asntransformer.com  
 http://www.asntransformer.com