

Part No. AS4812-U-0400-240-D



Type EI48/12

Power 4.0VA

Weight 205g

shipping unit per box: 20 PCS

temperature class: ta 70°C/B

Vacuum filled casting

Split bobbin design winding

Dielectric strength 4500Vrms

PART NO	Output ta 70°C/B	Prim.V	Connecting pins	Operating point sec. ± 10%	Connecting pins	No-load voltage V ± 10%
AS4812-U-0400-240-D	4.0W	115	2--6	24V 83.3mA	9--10	34.8V
				24V 83.3mA	12--13	34.8V

According to

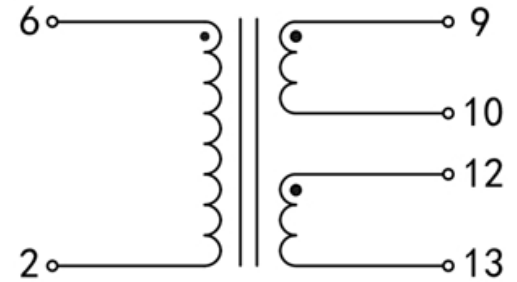
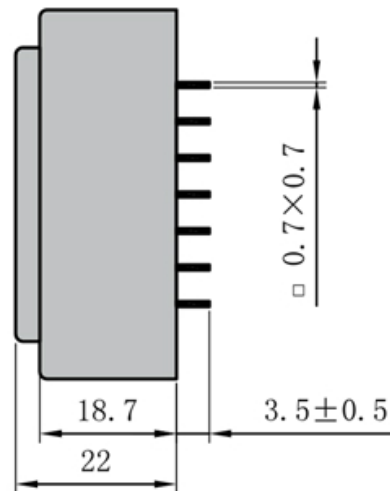
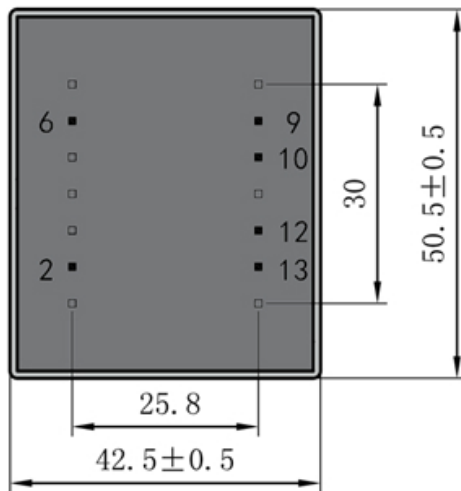

Dimensions with no indication of tolerances: ± 0.3mm
Custom-made transformer also will be welcome.



ADD: 699 Fangzhou Road Xiongzhou Town Luhe District 211500 Nanjing City Jiangsu China
 TEL: +86 25 57120866 / 57120966 - 8001 FAX: +86 25 57118989
 E-mail: asn@asn.cn / asn@asntransformer.com
 http://www.asntransformer.com