

Part No. AS4812-U-0400-120-S



Type EI48/12

Power 4.0VA

Weight 205g

shipping unit per box: 20 PCS. temperature class: ta 70°C/B

Vacuum filled casting

Split bobbin design winding

Dielectric strength 4500Vrms

PART NO	Output ta 70°C/B	Prim.V	Connecting pins	Operating point sec. ± 10%	Connecting pins	No-load voltage ± 10%
AS4812-U-0400-120-S	4.0 W	115	2--6	12V 333.3mA	10--12	17.4V

According to

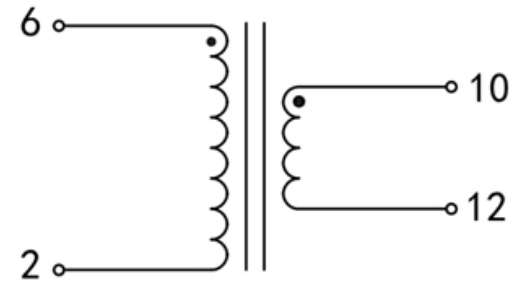
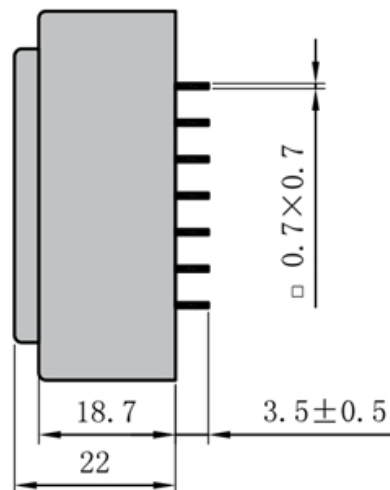
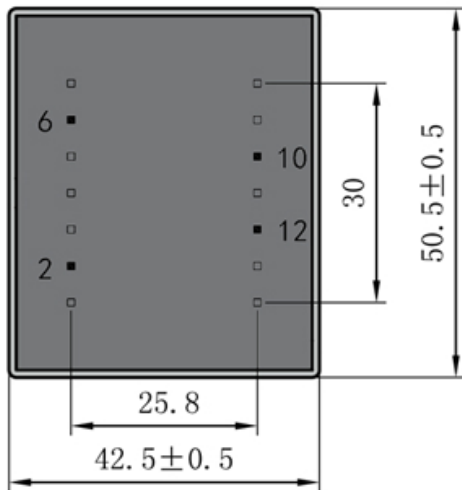

Dimensions with no indication of tolerances: ± 0.3mm
Custom-made transformer also will be welcome.

