

Part No. AS3005-E-0060-150-D



Type EI30/5

Power 0.6VA

Weight 43g

shipping unit per box: 40 PCS

temperature class: ta 50°C/B

Safety transformer/Short circuit proof

Vacuum filled casting

Split bobbin design winding

with VDE, ENEC 10, UL, CE, CB certificates

Dielectric strength 4500Vrms

PART NO	Output ta 50°C/B	Prim.V	Connecting pins	Operating point sec. ± 10%	Connecting pins	No-load voltage V ± 10%
AS3005-E-0060-150-D	0.6W	230	1--5	15V 20.0mA	6--7	23.3V
				15V 20.0mA	9--10	23.3V

Approved by

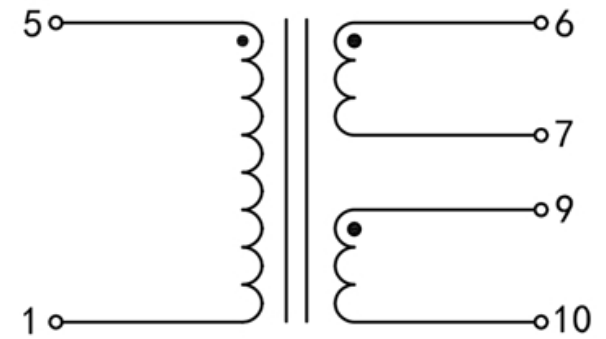
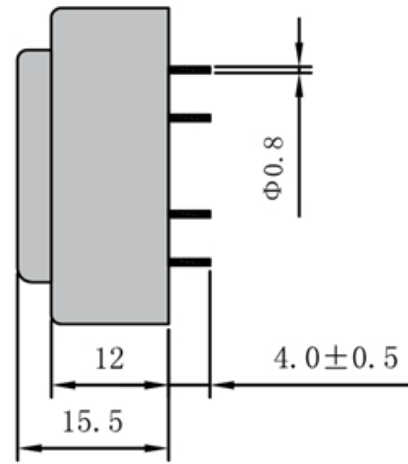
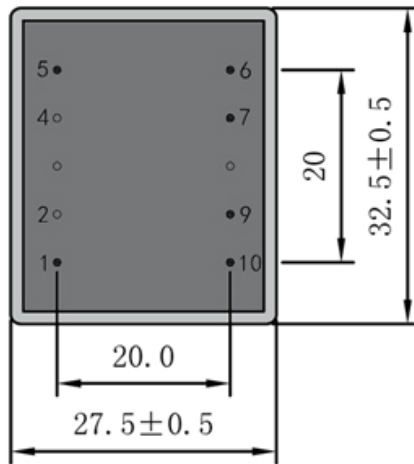

Dimensions with no indication of tolerances: ± 0.3mm
Custom-made transformer also will be welcome.

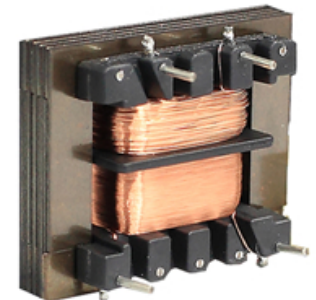

ADD: 699 Fangzhou Road Xiongzhou Town Luhe District 211500 Nanjing City Jiangsu China

TEL: +86 25 57120866 / 57120966 - 8001

FAX: +86 25 57118989

E-mail: asn@asn.cn / asn@asntransformer.com

http://www.asntransformer.com